



Department of
Primary Industries and
Regional Development

Research Library

Bulletins 4000 -

Research Publications

6-2002

Total grazing management field guide self-mustering systems for cattle, sheep and goats

C Underwood

Follow this and additional works at: <https://researchlibrary.agric.wa.gov.au/bulletins>



Part of the [Agriculture Commons](#), and the [Animal Sciences Commons](#)

Recommended Citation

Underwood, C. (2002), *Total grazing management field guide self-mustering systems for cattle, sheep and goats*. Department of Primary Industries and Regional Development, Western Australia, Perth. Bulletin 4547.

This bulletin is brought to you for free and open access by the Research Publications at Research Library. It has been accepted for inclusion in Bulletins 4000 - by an authorized administrator of Research Library. For more information, please contact library@dpird.wa.gov.au.

Bulletin No. 4547
ISSN: 1326-415X
June 2002

Total grazing management FIELD GUIDE

Self-mustering systems for cattle, sheep and goats

C. Underwood



Department of
Agriculture



Natural
Heritage
Trust

*Helping Communities
Helping Australia*

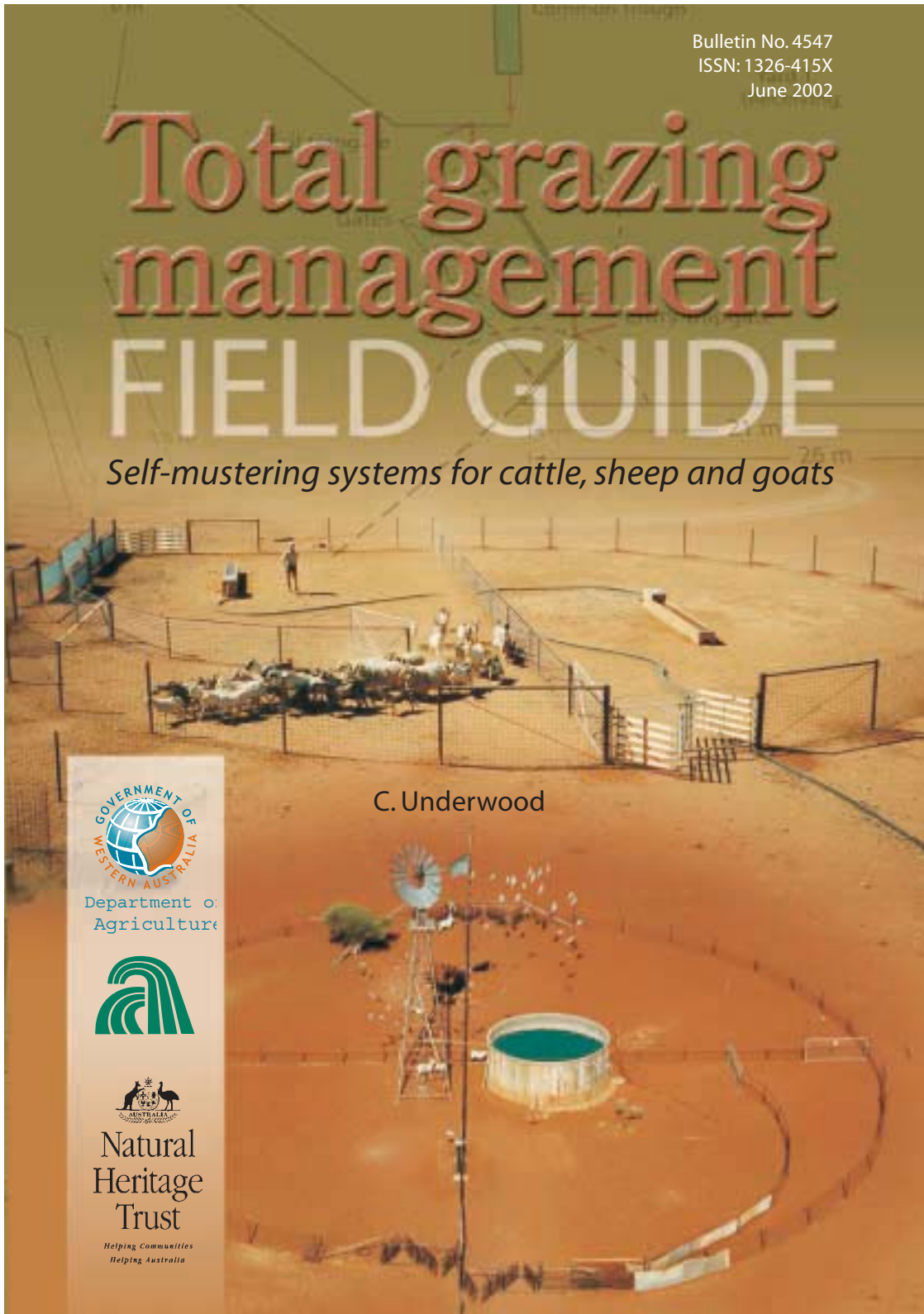

Disclaimer: Whilst this document has been prepared in good faith with all due care, the State of Western Australia and its agents, servants and officers accept no responsibility for its accuracy, currency, reliability or correctness caused by changes in circumstances after the time of publication or collection of the information or in so far as it incorporates information provided by third parties. Users of this document should obtain their own advice and conduct their own investigations and assessments of any proposals that they are considering in light of their own individual circumstances.

The State of Western Australia, the author and the publisher, their respective servants and agents accept no responsibility for any person acting on, or relying on, or upon any opinion, advice, representation, statement of information whether expressed or implied in the document, and disclaim all liability for any loss, damage, cost or expense incurred or arising by reason of any person using or relying on the information contained in the document (whether such error, omission or mis-statement is caused by or arises from negligence, lack of care or otherwise).

The product trade names in this publication are supplied on the understanding that no preference between equivalent products is intended and that the inclusion of a product does not imply endorsement by the Department of Agriculture Western Australia over any other equivalent product from another manufacturer. Any omission of a trade name is unintentional. Recommendations were current at the time of preparation of this material.

Total Grazing Management FIELD GUIDE

*Self-mustering systems for
cattle, sheep and goats*

C. Underwood

Department of Agriculture Western Australia



Natural Heritage Trust
Helping Communities Helping Australia

© 2002 Department of Agriculture Western Australia

Acknowledgments

Cattle trapyard designs by J. Addison.

Original development of TGM sheep and goat systems
carried out by D. Pearce and
G. Eliot during the Pimbee Station trial.



Contents

Introduction	5
Advantages of TGM systems.....	6
Western Australian producer's comments on TGM.....	7
Section 1. TGM Systems – How do they work?	8
Permanent trapyards.....	8
Total grazing pressure.....	8
Trapyards and kangaroos.....	9
Section 2. TGM Sheep and Goat Systems	10
Marking out and construction	10
Trapyard designs.....	10
Trapgates	15
Add-on features to TGM yards.....	16
Section 3. TGM Cattle Systems	17
Training.....	17
Trapyard designs.....	17
Trapgates	21
Further information and contacts.....	22

Introduction

Total grazing management (TGM) systems were designed to assist producers in the Western Australian rangelands to improve station productivity. TGM systems can increase the profits of pastoral properties by improving management control over grazing animals and by decreasing operating costs.

Over 1000 TGM yards have been put on the ground in the southern rangelands. The majority of these are sheep and goat systems, though an increasing number of cattle systems, and cattle, sheep and goat systems are being built.

This booklet is a practical guide to the types of TGM self-mustering systems available. It is designed to be used as a planning tool and as reference guide out in the paddock.

The TGM Field Guide has three main sections:

Section 1. TGM Systems – How do they work?	Page 8
Section 2. TGM Sheep and Goat Systems	Page 10
Section 3. TGM Cattle Systems	Page 17

Comments from Western Australian rangeland producers on their TGMs, as well as the benefits of TGM systems on station are included in the Introduction.



Advantages of TGM systems

TGM systems achieve the following benefits on station:

Decreased operating costs. The costs of labour, vehicles and fuel are strong limiting factors to station profit. TGM systems provide a self-mustering method that reduces - or avoids - the need for aerial mustering. Labour needs on station are therefore reduced as grazing animals trap themselves.

On-site animal handling. TGM systems allow for animal management tasks such as drafting, marking, bull and/or ram removal, and mulesing to occur on-site, saving time and vehicles.

Reduced animal stress. Aerial and ground mustering places stress on animals, including exhaustion, mismothering, and feeding and watering disruption. Self-mustering reduces these stresses, which in turn maintains animal condition.

Pasture management. Self-mustering systems assist the producer to adjust stocking rates to match feed on offer and animal condition. Pasture management practices such as resting paddocks and rotational grazing are also aided with TGM systems.

Higher mustering and trapping percentages. Station animals including feral goats can be more effectively mustered, which increases turnover and profit.

Improved control over supply. TGM systems can increase the producer's ability to maintain a steady supply of sale animals.

Improved workplace safety. Self-mustering can reduce the occurrence of mustering accidents and stress on workers.

Increased property values. TGM systems are permanent assets that add value to pastoral leases.

Comments from producers in the Western Australian rangelands

"Our TGM gets a trapping efficiency of 100 per cent and no straggler shearing is required. This reduces costs and increases profitability of wool line (a more even cut with less breaks). The stress on man and beast is reduced. TGM has been the best thing since sliced bread."

"A great advantage of the TGM trapyard is the capacity to draft animals on site."

"TGM has greatly improved feral goat mustering. 1500 - 3000 per year more goats have been trapped since TGM yards were put on the ground. TGM makes rotational grazing a simple, efficient and low-labour process. High mustering efficiency is achieved, while straggler shearing is not usually required."

"Sales of feral goats have increased significantly since TGM yards were put in place. TGMs are more effective than aerial mustering for goat capture."

"TGM systems have increased efficiency and flexibility and have reduced costs."

"Our cattle prefer to walk through our TGM trapgates than an open 3.5 metre gate"



Section 1. TGM Systems – How do they work?

Permanent trapyards

The primary tool of TGM is the permanent trapyard system, placed around water points such as troughs and dams. A TGM yard has access trapgates that are constantly used by station stock to enter and exit the yard. To muster animals, the exit trapgate is closed, and watering animals are prevented from leaving the yard. By controlling when and where animals are drinking, managers are effectively controlling those animals.

In TGM plans, permanent yards are placed on the areas on station that are likely to give best control over grazing animals. Areas where animals are most dependent on artificial water points, where best grazing country occurs or where high numbers of goats are present, may be such target areas. The way is then paved for TGM systems to be placed on all station waters, providing the manager with control over animals across the property.

TGM systems also assist the manager to rest paddocks and implement rotational grazing systems if required, as grazing animals can be self-mustered from paddock to paddock using permanent yards.

Total grazing pressure

Domestic stock are only one component of total grazing pressure. By applying the same principles that are used for domestic stock - such as the use of permanent trapyard systems around watering points - TGM can control feral animals as well.

Feral goat harvesting has increased where TGM systems have been put on the ground and income from feral goats trapped with TGM has provided positive cash flow for many graziers in the region. Indeed, income generated from goats trapped at the first few yards has allowed producers to expand the network of TGM yards on their properties, and improve their control over total grazing pressure.

Trapyards and kangaroos

The results of observational work, the trialing of a professional shooter, and feedback from producers has provided information on how to manage permanent trapping systems to prevent large numbers of kangaroos becoming trapped. The following techniques can be used as part of this management system:

Close the trapyard at night when trapping

Kangaroos predominantly seek water at night. By closing trapgates after daylight hours until dawn, kangaroos are prevented from entering yards at these times. The trapgates should be set for trapping again in the morning to allow for the watering period of domestic stock.

Introduce a kangaroo barrier

Chicken wire or rubber belting can be used on the top 20 cm of external mesh. This provides a physical and a visual barrier which prevents kangaroos from getting their hind legs caught in the mesh.



Section 2: TGM Sheep and Goat Systems

All designs for total grazing management sheep and goat enclosures have two essential features. These are:

- *permanent construction around water points; and*
- *permanently set entry and exit trapgates.*

To drink, the animals must walk into yards through the entry trapgate, and then walk out of the yard through the exit trapgate. Because the animals are doing this task all year, they become well trained, so that trapping becomes simply a matter of closing exit spears.

Marking out and construction

All yards should be marked out before construction. For circular trapyards, place a picket at the centre of the yard area and attach a rope that is half the diameter of the yard – that is, 19.5 metres for a 39 metre diameter yard. Keep the rope taut while walking in a circle, marking the ground with pegs every three metres for post spacings, allowing for the width of trapgates. Next, in one quarter of the circle, mark out the square loading section, the forcing bugle, race and internal mesh fences according to the yard plan (see pages 11 – 13).

Once the yard has been marked out, dig post holes to a depth of one metre. Concrete posts in place, using a string line for straight sections, and then weld railing onto internal posts and race posts. Lightly strain mesh onto the outside of posts with a vehicle, and twitch mesh onto posts with wire – twitching rather than welding mesh onto posts provides greater flexibility and strength, and reduces labour. Finally, put all trapgates and internal gates in place.

Trapyard designs

The following pages contain designs for sheep and goat TGM yards, along with a list of materials required. All yards have built-in drafting facilities that allow for on-site animal handling.

Figure 1: **Single paddock TGM yard**

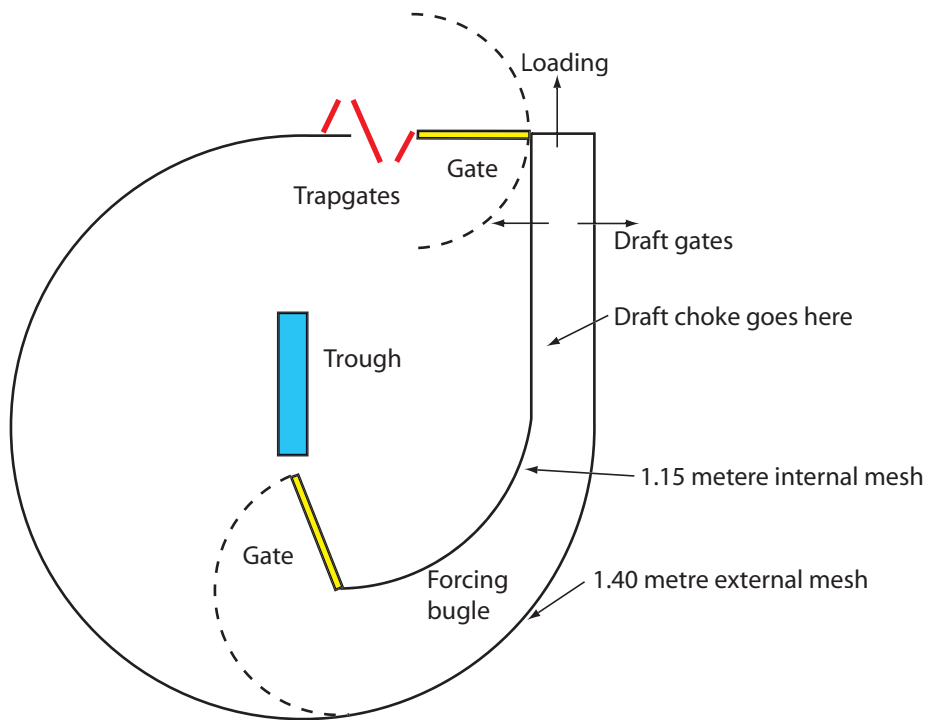

Dimensions

Radius - yard centre to external mesh: 9.5 metres (diameter 19 metres)

Materials

- 1 set entry/exit trapgates
- 1 x 60 m rolls 1.40 m septic tank mesh (external mesh)
- 0.4 x 60 m roll 1.15 m septic tank mesh (internal mesh)
- 30 posts - minimum 40 mm nominal bore (at 3 m spacings)
- 1-2 gates (3 m width), and a set of drafting gates
- Cap railing
- Consumables (concrete and so forth)
- Pressed tin (corrugated iron) for blanking out race/bugle

Figure 2: **Two paddock TGM yard**

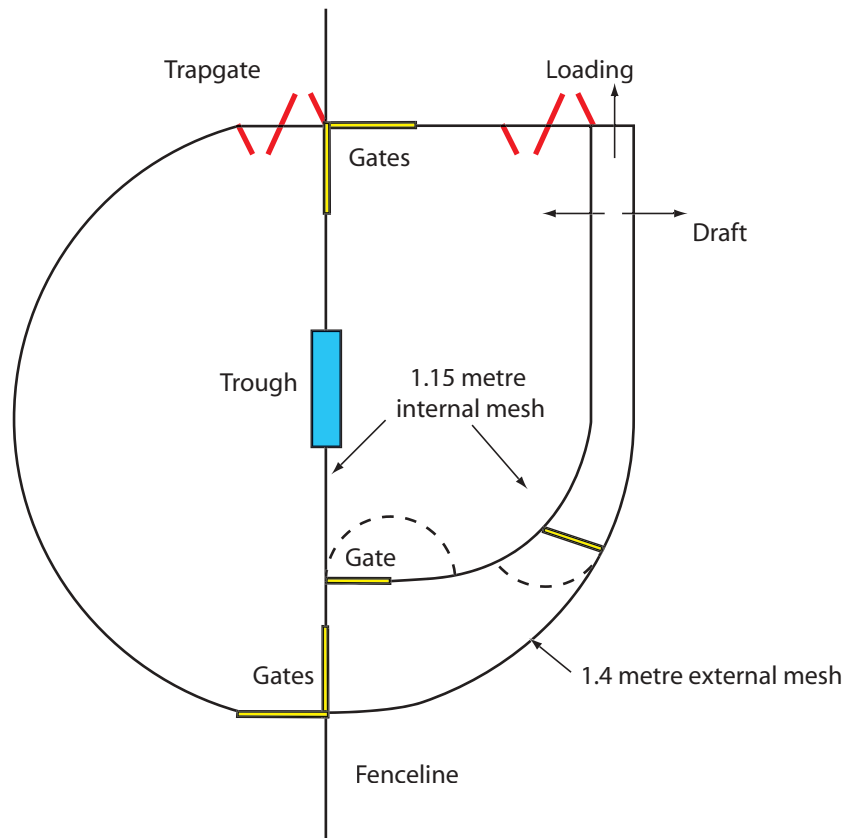

Dimensions

Radius - yard centre to external mesh: 14.5 metres (diameter 29 metres)

Materials

- 2 sets entry/exit trapgates
- 1.5 x 60 m rolls 1.40 m septic tank mesh (external mesh)
- 1 x 60 m roll 1.15 m septic tank mesh (internal mesh)
- 48 posts - minimum 40 mm nominal bore (at 3 m spacings)
- 3 x 3 m gates (6 are ideal), and a set of drafting gates
- Consumables (concrete and so forth), including cap railing
- Pressed tin (corrugated iron) for blanking out race/bugle

Figure 3: **Four paddock TGM yard**

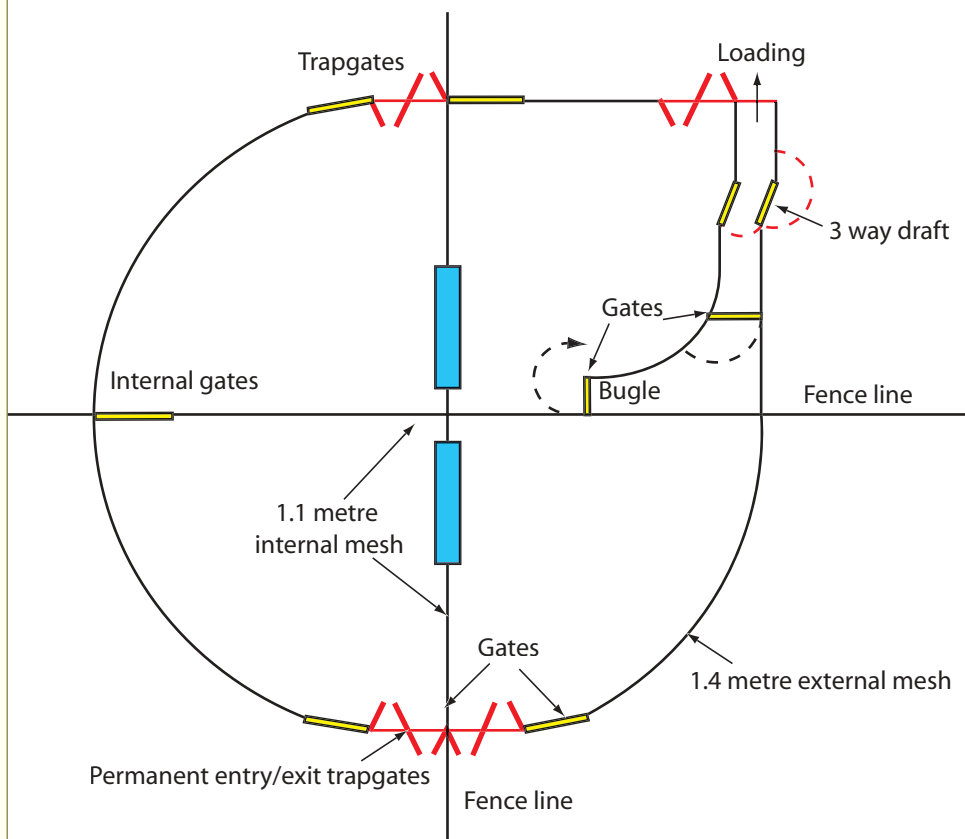

Dimensions

Radius - yard centre to external mesh: 19.5 metres (diameter 39 metres)

Materials

- 4 sets entry/exit trapgates
- 2 x 60 m rolls 1.40 m septic tank mesh (external mesh)
- 1.8 x 60 m roll 1.15 m septic tank mesh (internal mesh)
- 82 posts - minimum 40 mm nominal bore (at 3 m spacings)
- 5 x 3 m gates minimum (9 are ideal), and a set of drafting gates
- Consumables (concrete and so forth), including cap railing
- Pressed tin (corrugated iron) for blanking out race/bugle

Figure 4: **TGM yard at a dam**

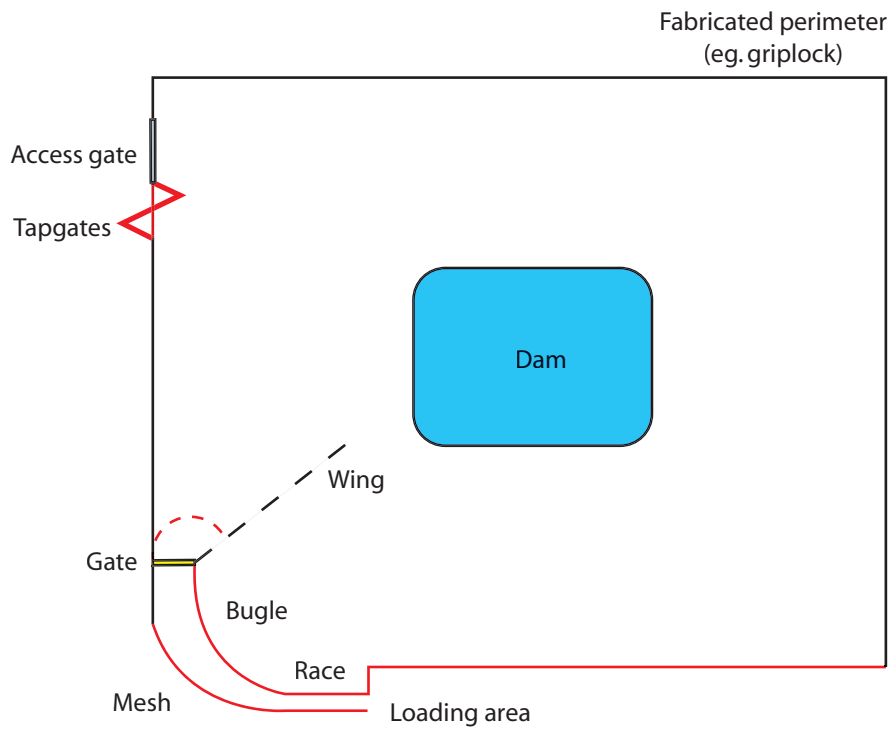

Dimensions

100 m x 100 m enclosure around a dam.

Materials

- ~ 55 posts (steel pickets)
- 400 m fabricated fence (such as griplock)
- Barbed wire
- 4 end assemblies
- 1 trapgate
- 1 x 60 m roll 1.4 m mesh
- 1 x 60 m roll 1.15 m mesh
- 2 gates
- 19 x 2.5 m posts
- 16 x 2.0 m posts

Trapgates

A range of sheep and goat prefabricated trapgates are on the market, ranging in price and quality from \$350 to \$500. The Carnarvon Office of the Agency has plans for trapgates that can be made on station, or by a steel fabricator. Plans on hand include the 'Pimbee' trapgate (Figure 5 below) and the rubber sprung trapgate.

Table 1: Manufacturers of prefabricated trapgates
(not an exhaustive list)

Manufacturer	Product
Commander Agquip Dalwallinu 9661 1333	Cattle gate Cattle/sheep/goat trapgate Sheep/goat trapgate
Elders Carnarvon 9941 1554	Sheep/goat trapgate
Withnells Stockyards Bindoon 9576 1094	Sheep/goat trapgate Cattle trapgate
Wesfarmers Carnarvon 9941 4170	Sheep/goat trapgate
Agri Gates, Naval Base 9437 1419	Trapgates made to required specifications



Figure 5: **A TGM Sheep and goat trapgate**

Add-on features to TGM yards

The following features will increase the strength and workability of TGM sheep and goat yards.

- Type of trapgates used. Good quality prefabricated trapgates do a superior job for many years.
- The use of conveyor belting or concrete aprons underneath trapgates. This prevents the stock pads from gouging out the dirt beneath spears, allowing animals to escape.
- The use of blank out panels (rubber or corrugated iron) on drafting-loading race. This improves animal movement during drafting and loading.
- The use of cap rails on internal fences and race, to improve strength and ease of movement in the yard.
- Extra gate in the forcing bugle, to improve drafting-loading.
- The inclusion of a holding yard, to increase the ability for on-site animal management.
- The use of a 'Y' frame in the drafting race to restrict animal movement to one at a time down the race (see Figure 6 below).

Figure 6: 'Y' frame design, to fit in drafting/loading race – made from pressed tin or sheet metal.

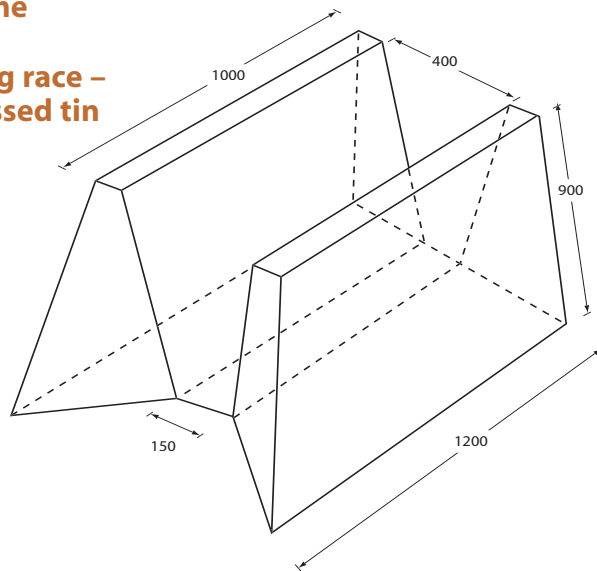

Section 3. TGM Cattle Systems

TGM cattle trapyards work on the same principles as sheep and goat yard designs. Yards are permanent, with entry and exit trapgates set all year round. To achieve good control over grazing animals, they need to be trained to access water through trapgates. Producer feedback and video monitoring footage has shown that animals which regularly use trapgates do so easily and without hesitation. In some cases, cattle have shown a preference to using trapgates over adjacent open gates.

Training

Training is an essential process that usually takes three to four weeks. The spears should be left off the gates for about a week to familiarise stock with entry and exit areas. The spears should then be placed on the trapgate at the wider setting - the training setting - for a week or two. Keep an eye on the yard during this time to make sure cattle are learning how to use the system.

Following this period the spears can be set at the trapping setting as by this time stock will be trained. For self-mustering to work effectively, it is important to leave the trapgates permanently set so that the stock behaviour becomes ingrained.

Trapyards

Apart from the common feature of permanently set trapgates, the design of TGM cattle yards is flexible; they reflect the individual needs of each property. This will depend on the number of animals to be held and/or processed. If working facilities such as drafts and crushes are needed on-site, then these can be included in yard plans. Holding yards, loading ramps and mustering wings also may be built into plans if needed.

The following pages contain examples of TGM cattle yard designs.

Figure 7: **Basic TGM cattle yard with no processing features.**
The yard has a capacity of ~ 100 head
(@ 4-5 m² per head)

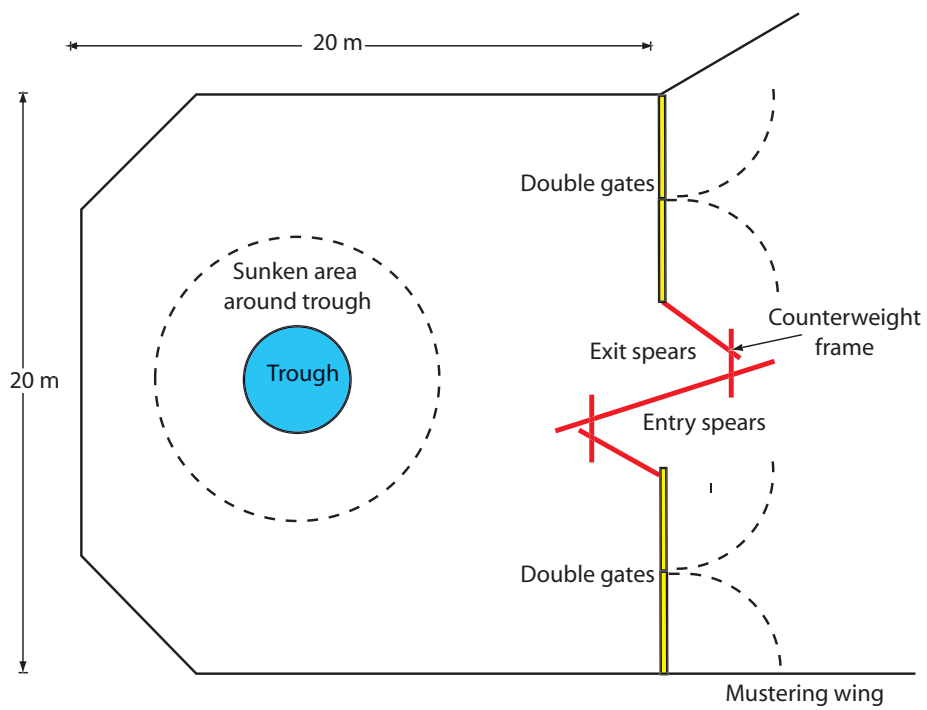

Figure 8: **TGM yard with working and holding facilities. The yard has a capacity of ~ 115 head**

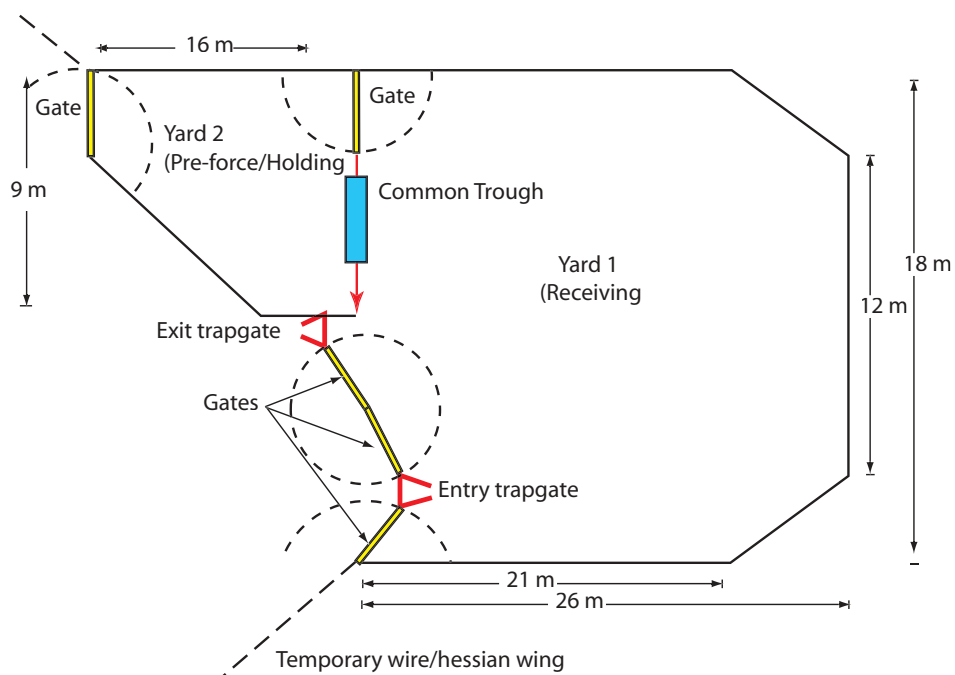
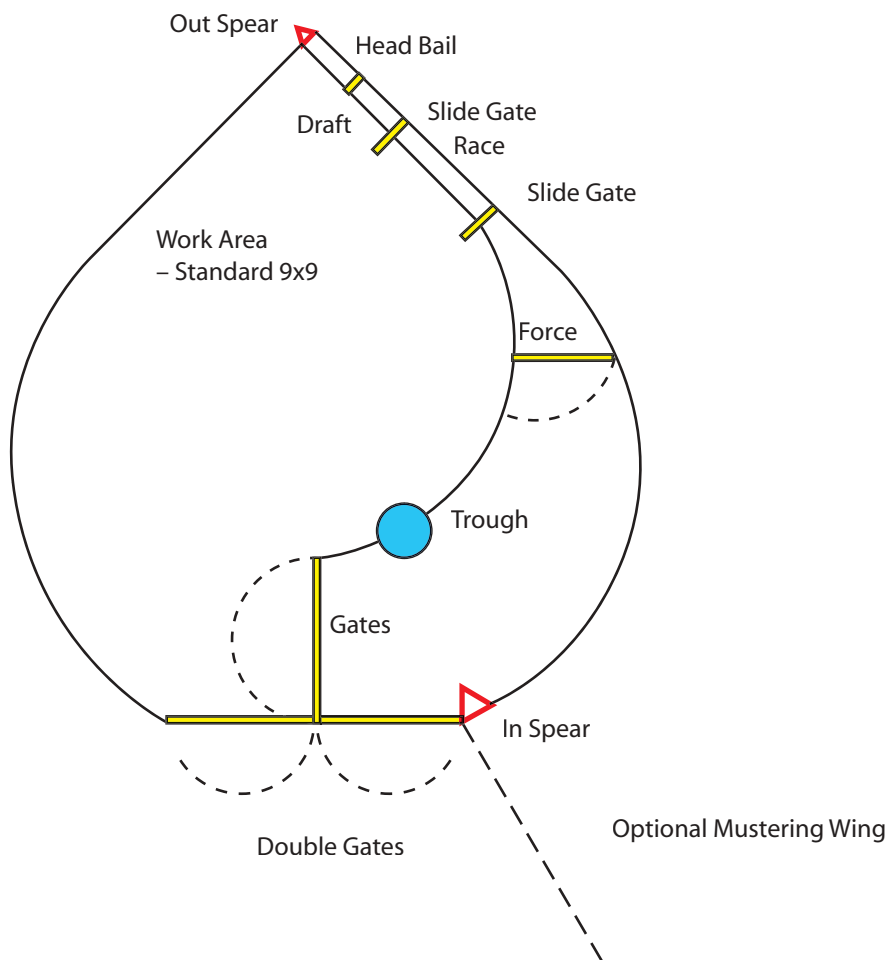

Figure 9: **Cattle TGM with race-walk-through.** The exit trapgate is at the end of the race so cattle must walk down the race to leave the yard. Cattle are easier to handle in the race at drafting and branding time as a result – we recommend a concrete or gravel floor on the race



Trapgates

Long arm and short arm spear designs have been used by cattlemen in the northern areas of Australia for many years. Below is a short arm trapgate suitable for use by cattle, sheep and goats. Short arm, gravity operated spears such as this are strong, durable and low maintenance.



Several modifications have been made to this gate including:

- A simple adjustment mechanism that allows the space between the spear tips to be changed from a training setting (~ 300 mm) to a trapping setting (~ 100 mm), by shifting the spears from one side of the frame to the other.
- Welding mesh or see-through blinds on the lowest spear arm to prevent sheep and goats escaping – the sleeve angle on these lowest arms has been reduced from 30 to 13 to make it easier for small stock to push them open.
- Slightly longer spear arms create more of a funnel for stock to enter, and reduce the possibility of goats returning through the in spears.

The Department of Agriculture Carnarvon has designs for this trapgate, so that they can be made on station or by a steel fabricator. The gate pictured was manufactured for about \$400.



Further information

Department of Agriculture District Offices have a range of more detailed information on total grazing management self-mustering systems, including:

- trapyard designs and materials for cattle, goats and sheep;
- trapgate designs and materials;
- general animal management technologies.

As well, visit the total grazing management website at <http://www.agric.wa.gov.au/tgm>.

Contact details

Telephone	Carnarvon District Office	9956 3333
	Meekatharra District Office	9981 1105
Fax	Carnarvon District Office	9941 8334
	Meekatharra District Office	9981 1571



